

BASIC INFORMATION

Straumann® Bone Level Tapered Implant



ABOUT THIS GUIDE

The *Straumann® Bone Level Tapered Implant, Basic Information (702167/en)* provides dental practitioners and related specialists with the essential steps regarding surgical treatment and procedures for the Straumann® Bone Level Tapered Implant.

It is assumed that the user is familiar with placing dental implants. For further information, please see the *Straumann® Dental Implant System, Basic Information (702084/en)* and other existing Straumann procedure manuals that are referred to throughout this document.

CONTENTS

1	THE STRAUMANN® BONE LEVEL TAPERED IMPLANT	2
2	IMPLANT	3
	2.1 Design and specifications	3
	2.2 Material	4
	2.3 Surface	4
	2.4 Transfer piece	4
	2.5 Prosthetic connection	5
3	INDICATIONS	6
4	PLANNING	6
	4.1 Preoperative planning	6
	4.2 Planning aids	11
5	SURGICAL PROCEDURE	13
	5.1 Straumann® Bone Level Tapered Ø 2.9 mm SC	13
	5.2 Straumann® Bone Level Tapered Ø 3.3 mm, Ø 4.1 mm and Ø 4.8 mm	20
6	INSTRUMENTS	29
	6.1 Depth marks on Straumann® instruments	29
	6.2 Drill extender	29
	6.3 Ratchet	30
	6.4 Torque Control Device	31
	6.5 Cleaning and care of instruments	32
	6.6 Straumann® Modular Cassette	33
	6.7 BLT Drill, article list	34
7	IMPORTANT GUIDELINES	35

1 THE STRAUMANN® BONE LEVEL TAPERED IMPLANT

The Straumann® Dental Implant System offers two different implant lines, the Tissue Level Implants and the Bone Level Implants.

The Bone Level Implants are suitable for bone level treatments in combination with transgingival or submucosal healing. The rough implant surface extends to the top of the implant and the connection is shifted inwards.

The Straumann® Bone Level Tapered Implant features the established and clinically proven Straumann® Bone Control Design™ and the CrossFit® connection together with its corresponding prosthetic CrossFit® components from the Bone Level Implant product portfolio. It has an apically tapered and self-cutting design, making this implant particularly suitable for situations involving soft bone/very soft bone or fresh extraction sockets where primary stability is key.

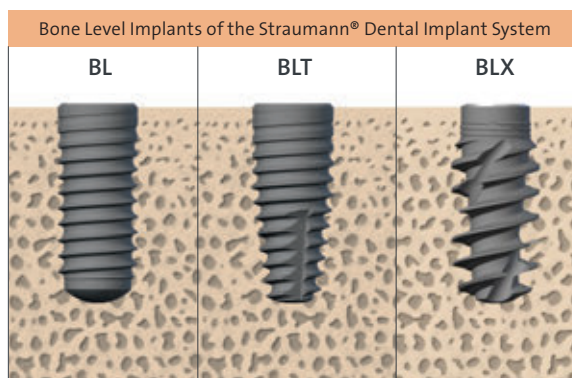

The Straumann® Bone Level Tapered Implant comes in the materials Roxolid® with the SLActive® and SLA® surface, or titanium with an SLA® surface.*

A unified color code simplifies identification of instruments and implants for the available endosteal diameters of Ø 2.9 mm, Ø 3.3 mm, Ø 4.1 mm, and Ø 4.8 mm.

Color coding		
● blue	blue	Endosteal implant diameter 2.9 mm
● yellow	yellow	Endosteal implant diameter 3.3 mm
● red	red	Endosteal implant diameter 4.1 mm
● green	green	Endosteal implant diameter 4.8 mm

* Some of the Straumann products listed here may not be available in all countries. Implants with endosteal diameter 2.9 mm are not available in titanium.

2 IMPLANT

2.1 DESIGN AND SPECIFICATIONS

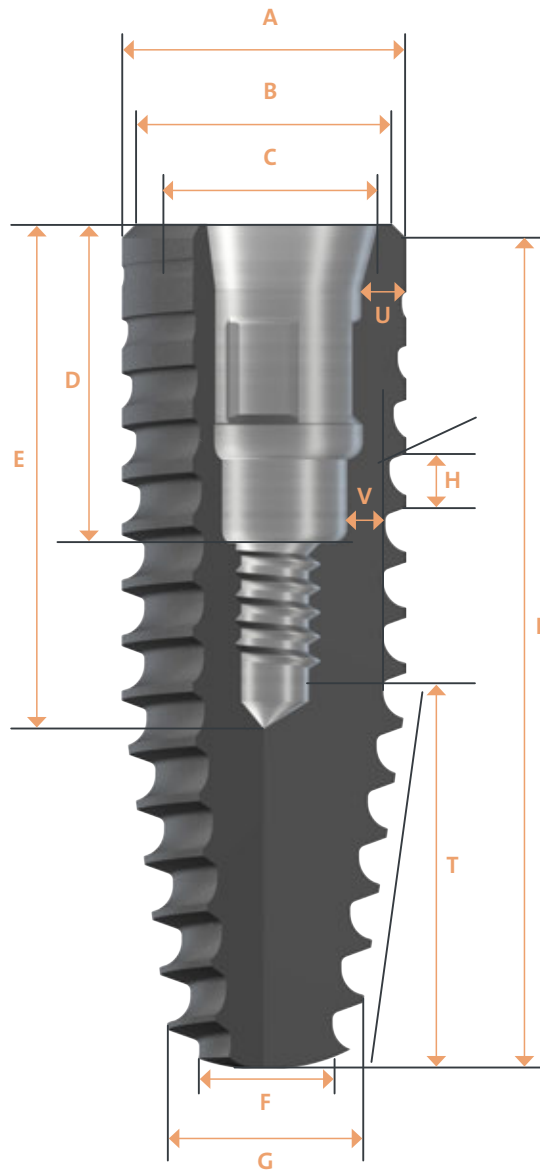

	Bone Level Tapered	SDI Ø2.9	BLT Ø3.3	BLT Ø4.1	BLT Ø4.8
A	Diameter	Ø2.9 mm	Ø3.3 mm	Ø4.1 mm	Ø4.8 mm
B	Platform	Ø2.8 mm	Ø3.1 mm	Ø3.7 mm	Ø4.4 mm
C	Connection diameter	SC Ø2.3 mm	NC Ø2.8 mm	RC Ø3.3 mm	
D	Connection depth	3.6 mm	4.6 mm		
E	Connection depth incl. screw hole	5.6 mm	6.9 mm		
F	Apical diameter core	Ø0.6 mm	Ø1.1 mm	Ø1.8 mm	Ø2.3 mm
G	Apical diameter threads	Ø1.5 mm	Ø2.0 mm	Ø2.7 mm	Ø3.2 mm
H	Thread pitch / flank lead / depth	0.8 mm / 20° / 0.3 mm			
L	Lengths	10 - 14 mm	8 - 18 mm		
T	Tapered part / taper	3.9 mm/11°	5.3 mm/9°		5.8 mm/9°
U	Wall thickness - top	0.6 mm		0.7 mm	1.0 mm
V	Wall thickness - mid	0.5 mm	0.6 mm		0.9 mm

2.2 MATERIAL

Roxid[®] is a groundbreaking material specifically designed for use in dental implantology. The titanium-zirconium alloy is stronger than pure titanium^{1,2} and has excellent osseointegration properties³⁻⁵. This combination of properties is unique in the market, since no other metallic alloy unifies high mechanical strength and osteoconductivity.

Thanks to their outstanding biological and mechanical properties, Roxid[®] Implants offer more treatment options than conventional titanium implants.

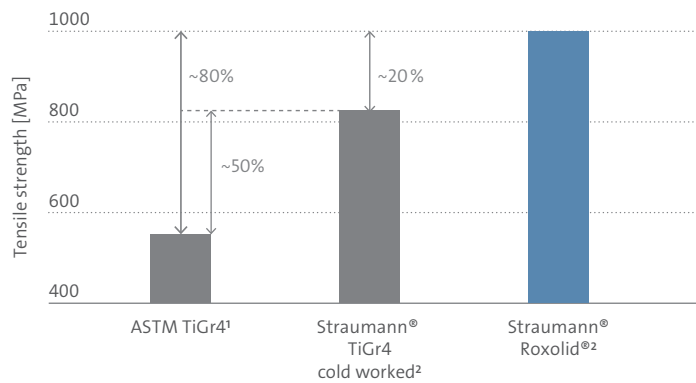

Roxid[®] shows a 20% higher tensile strength than Straumann cold-worked titanium and a 80% higher strength than standard titanium Grade 4.

2.3 SURFACE

SLActive[®] significantly accelerates the osseointegration process and delivers everything you expect from a successful and patient-friendly implant treatment.

- Safer and faster treatment in 3-4 weeks for all indications¹⁰⁻¹⁹
- SLActive[®] reduces initial healing time to 3-4 weeks*
- Increased treatment predictability in critical protocols⁶

Most implant failures occur in the critical early period between weeks 2 and 4⁷. Although similar healing patterns were observed for both SLA[®] and SLActive[®] Implants, bone-to-implant contact (BIC) was greater after 2 weeks and significantly greater after 4 weeks for SLActive[®] (p-value < 0.05).⁸

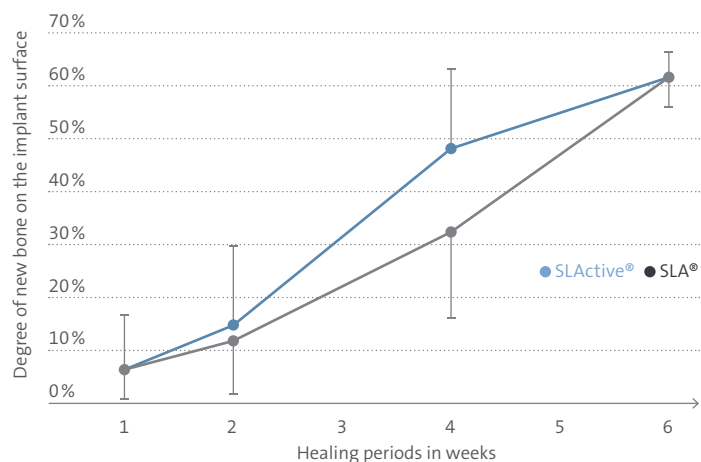

The SLActive[®] surface shows a faster integration into new bone after 4 weeks (50%) compared to the SLA[®] surface (30%).

2.4 TRANSFER PIECE

The Bone Level Tapered Implants are delivered with the Loxim[®] Transfer Piece, which is connected to the implant with a snap-in mounting.

Features	Benefits
Snap-in mounting for easy handling without counter-maneuvering
Blue color for high visibility
Compact dimensions for easy access
Height markings for correct implant placement
Pre-determined breaking point avoids bone overcompression

*Healing time defined by BIC and stability (Lang et. al 2011, Oates et al. 2007, Nicolau P et al. 2019, Reis R et al. 2019, Eckert SE et al. 2019)

2.5 PROSTHETIC CONNECTION

The CrossFit® connection of Bone Level Implants applies the know-how and benefits from the Straumann® synOcta® Morse taper connection to the connection requirements at bone level. The mechanically locking friction fit of the 15° conical-cylindrical CrossFit® connection with four internal grooves has excellent long-term stability under all loading conditions and virtually eliminates screw loosening. Bone Level Ø 4.1 mm and Ø 4.8 mm Implants have the same connection, the Regular CrossFit® connection (RC), and they share the same secondary components. Bone Level Ø 3.3 mm Implants feature the Narrow CrossFit® connection (NC). Bone Level Ø 2.9 mm Implants feature the Small CrossFit® connection (SC).

For the CrossFit® connection, Straumann offers a broad range of standard and CAD/CAM abutments in advanced materials and a full application range – designed to create the optimal restorative results for virtually any case. For ease of use, you need only one restorative kit for all Bone Level Implants. This single kit is easy to master, simple to handle and allows for convenient component management.

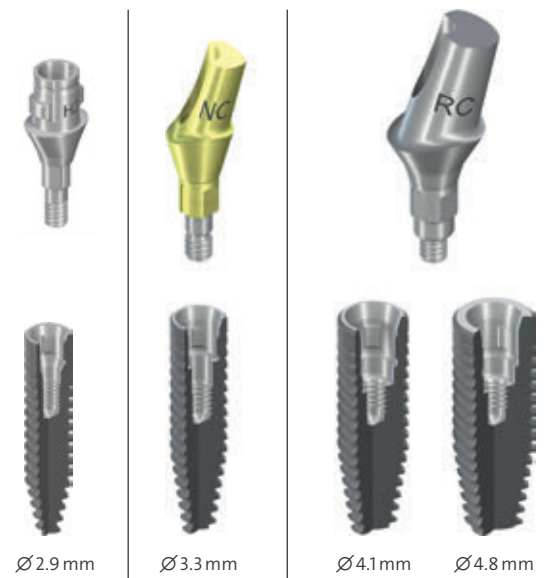

	SC	NC/RC									
	Single unit replacement	Single and multi-unit replacement			Edentulous treatment						
	Screw-/cement-retained	Screw-retained		Cement-retained	Fixed		Removable				
Premium											
Advanced											
Standard											

Key

Premium: Solutions for cases requiring a higher degree of individualization, zirconia for high esthetics, or high noble gold alloys.

Advanced: Technically advanced solution for cases requiring a higher degree of individualization.



Standard: Cost-effective solution with standard components and techniques for straightforward cases.

** Base abutment providing flexible solutions ranging from cost effective to high esthetics*

3 INDICATIONS

To obtain more information about indications and contraindications related to each implant, please refer to the corresponding instructions for use. Instructions for use can be found on www.ifu.straumann.com

The Straumann® Bone Level Tapered Implants (BLT) are offered in different diameters with distinctive features for each diameter:

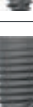
Specific indications for Straumann® implants:					
Implant type		Distinctive features	Minimal ridge width*	Minimal gap width**	Available lengths
BLT Ø2.9mm SC		<ul style="list-style-type: none"> Small-diameter implant for central and lateral incisors in the mandible, and lateral incisors in the maxilla 	5.0 mm	5.0 mm	10–14 mm
BLT Ø3.3mm NC		<ul style="list-style-type: none"> Small-diameter implant for narrow interdental spaces and bone ridges 	5.5 mm	5.5 mm	8–18 mm
BLT Ø4.1mm RC		<ul style="list-style-type: none"> For oral endosteal implant indications in the maxilla and mandible, for functional and esthetic rehabilitation of edentulous and partially edentulous patients 	6 mm	6 mm	8–18 mm
BLT Ø4.8mm RC		<ul style="list-style-type: none"> For oral endosteal implant indications in the maxilla and mandible, for functional and esthetic rehabilitation of edentulous and partially edentulous patients BLT Ø4.8 mm Implants are especially suited for wider interdental spaces and ridges 	7 mm	7 mm	8–18 mm

* Minimal ridge width: Minimal orofacial ridge width, rounded to 0.5 mm

** Minimal gap width: Minimal mesial-distal gap width for a single-tooth restoration, between adjacent teeth, rounded to 0.5 mm

4 PLANNING

4.1 PREOPERATIVE PLANNING

The implant is the focal point of the dental restoration. It provides the basis for planning the surgical procedure. Close communication between the patient, dentist, surgeon and dental technician is imperative for achieving the desired esthetic result.

To establish the topographical situation, the axial orientation, and the choice of implants, we recommend the following:

- Make a wax-up/set-up on the previously prepared study cast or use an implant planning software like coDiagnostiX® in conjunction with the patient's medical image data.
- Define the type of superstructure.

The wax-up/set-up can later be used as the basis for a custom-made X-ray Template or drill template and for a temporary restoration.

The implant diameter, implant type, position and number of implants should be selected individually, taking the anatomy and spatial circumstances (e.g. malpositioned or inclined teeth) into account. The measurements given here should be regarded as minimum guidelines. Only when the minimum distances are observed is it possible to design the restoration so that the necessary oral hygiene measures can be carried out.

The final hard and soft tissue response is influenced by the position between the implant and the proposed restoration. Therefore, it should be based on the position of the implant-abutment connection. The implant position can be viewed in three dimensions:

- Mesiodistal
- Orofacial
- Coronoapical

Note: The abutments should always be loaded axially. Ideally, the long axis of the implant is aligned with the cusps of the opposing tooth. Extreme cusp formation should be avoided. It can lead to unphysiological loading.

Mesiodistal implant position

The mesiodistal bone availability is an important factor for choosing the implant type and diameter as well as the inter-implant distances where multiple implants are placed. The point of reference on the implant for measuring mesiodistal distances is always the shoulder, being the most voluminous part of the implant. Note that all distances given in this chapter are rounded to 0.5 mm.

The following basic rules should be applied:

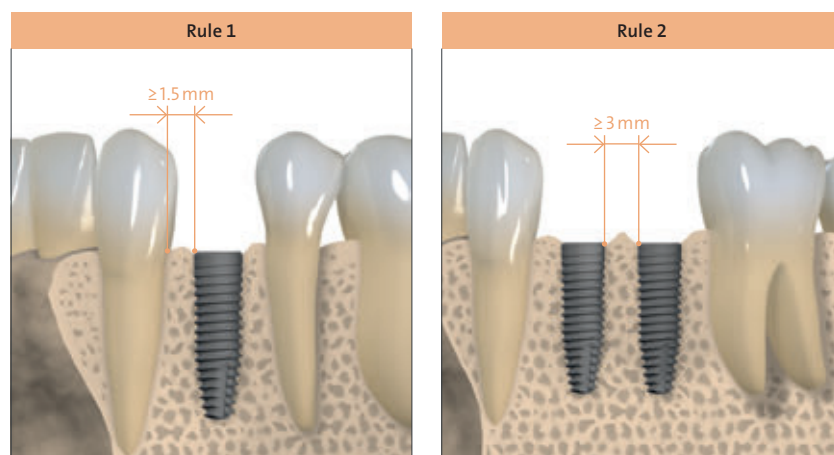

Rule 1: Distance to adjacent tooth at bone level

A minimal distance of 1.5 mm from the implant shoulder to the adjacent tooth at bone level (mesial and distal) is recommended.

Rule 2: Distance to adjacent implants at bone level

A minimal distance of 3 mm between two adjacent implants (mesiodistal) is recommended.

The following examples show how the rules 1 and 2 are implemented in multiple tooth gaps. The measurement is made at bone level from the adjacent tooth to the center of the implant and between implant centers. The minimal distance of 3 mm between two adjacent implants is important to facilitate flap adaptation, to avoid proximity of secondary components and to provide adequate space for maintenance and hygiene practices at home.

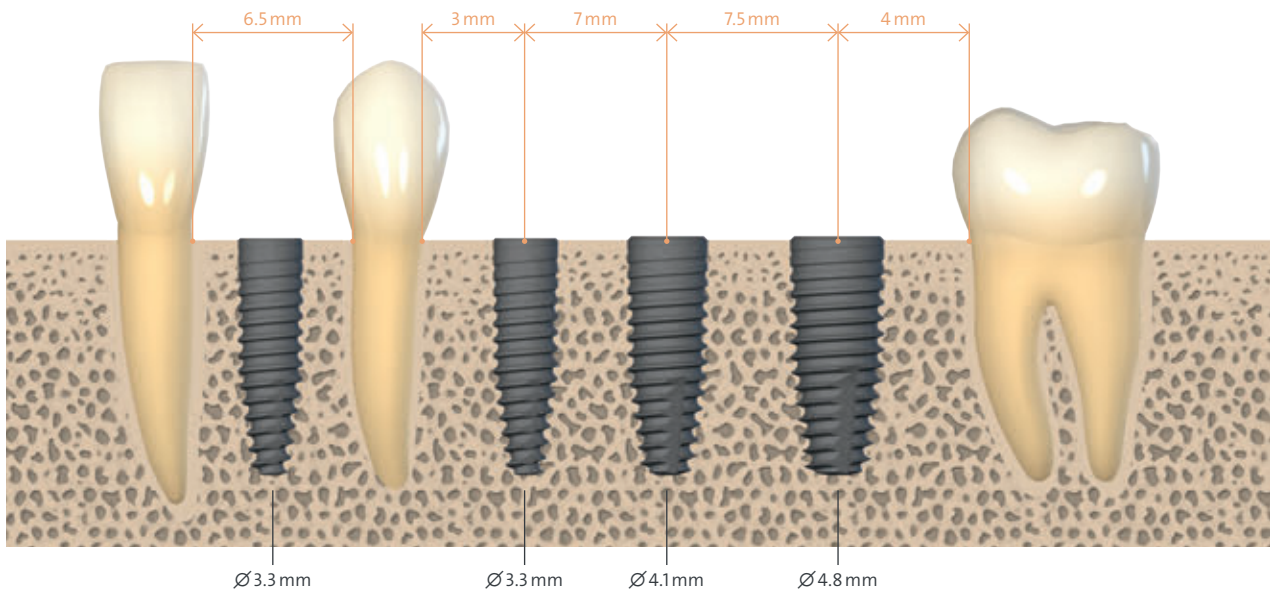

Orofacial implant position

The facial and palatal bone layers must be at least 1mm thick in order to ensure stable hard and soft tissue conditions. The minimal orofacial ridge widths for individual implant types are stated in chapter 3 *Indications*. Within this limitation, a restoration-driven orofacial implant position and axis should be chosen such that screw-retained restorations are possible.

Caution: An augmentation procedure is indicated where the orofacial bone wall is less than 1mm or a layer of bone is missing on one or more sides. This technique should be employed only by dentists who have adequate experience in the use of augmentation procedures.

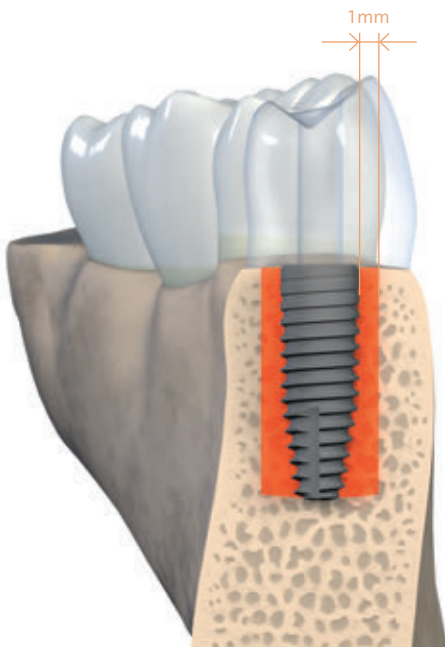

The layer of bone must be at least 1mm thick.

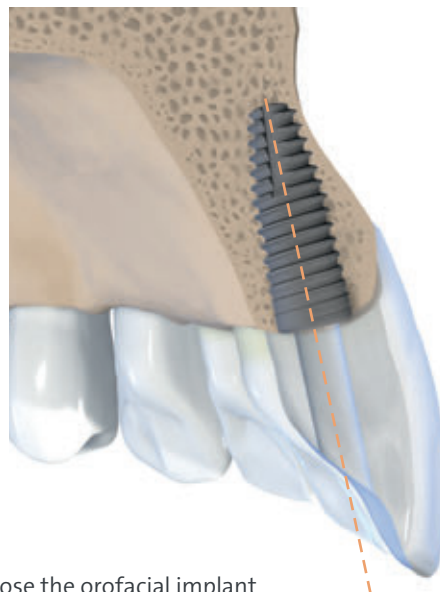

Choose the orofacial implant position and axis such that the screw channel of the screw-retained restoration is located behind the incisal edge.

Coronoapical implant position

Straumann® implants allow for flexible coronoapical implant positioning, depending on individual anatomy, implant site, the type of restoration planned, and preference.

The Bone Level Tapered Implant is best placed with the outer rim of the narrow 45° sloping edge (chamfer) at bone level.

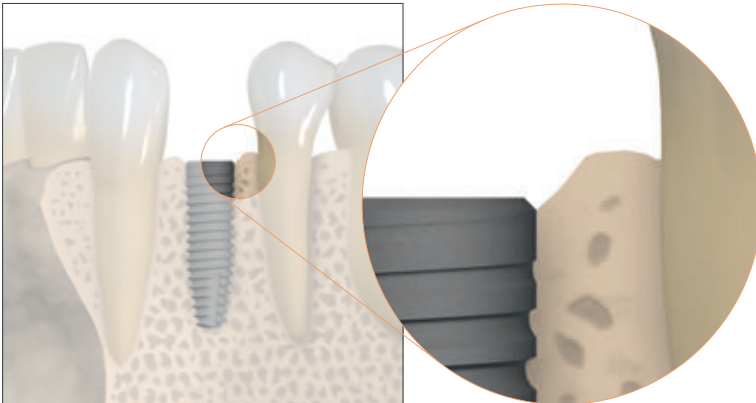

Ideally, in the esthetic region, the implant shoulder should be positioned about 3–4 mm sub-mucosal of the prospective gingival margin. The round markings in the Loxim® Transfer Piece indicate the distance to the implant shoulder in 1 mm steps.

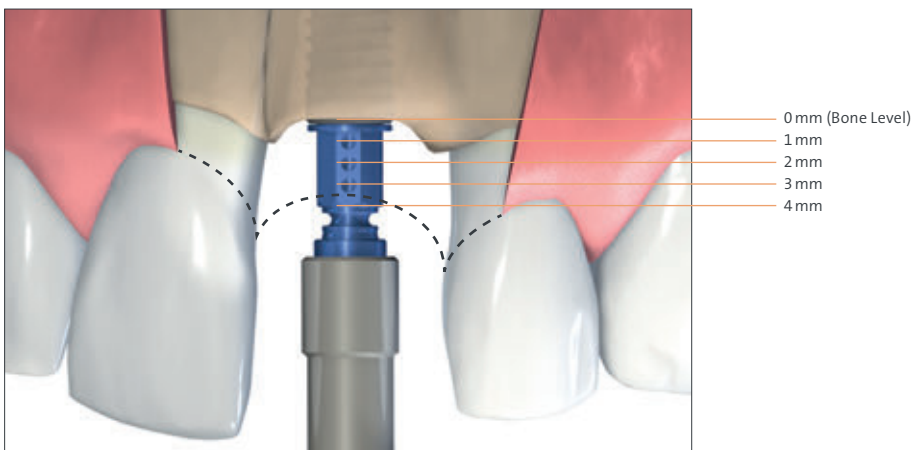

4.2 PLANNING AIDS

The vertical bone availability determines the maximum allowable length of the implant that can be placed. For easier determination of the vertical bone availability, we recommend the use of an X-ray Template (art. no. 025.0003) with X-ray Reference Spheres (art. no. 049.076V4).

4.2.1 Straumann® X-ray Templates

The X-ray Templates are used for measurement and comparison. They also assist the user in selecting the suitable implant type, diameter and length. To take account of the distortions that occur in X-rays, the implant dimensions are shown on the individual templates with the corresponding distortion factors (1:1 to 1.7:1).

Determining each magnification factor or scale is facilitated by showing the X-ray Reference Sphere on the template. First, compare the size of the X-ray Reference Sphere on the patient's X-ray with the size of the Reference Sphere on the template. Superimpose the two pictures to find the correct scale. Next, determine the spatial relations around the implant position, and establish the implant length and insertion depth.

4.2.2 coDiagnostiX®

There is also the possibility of digital planning with coDiagnostiX®. This 3D diagnostics and implant planning software is designed for the image-guided surgical planning of dental implants, including Bone Level Tapered Implants, which are included in the digital library of the system. Working with the software is based on a patient's medical image data such as a CT (Computed Tomography) or DVT (Digital Volume Tomography) scan that is processed by coDiagnostiX®.

Planning includes the calculation of several views (such as virtual OPG or a 3-dimensional reconstruction of the image dataset) and the analysis of the image data and the placement of implants, abutments and drilling sleeves.

coDiagnostiX® software is designed for use by professionals with appropriate knowledge in implantology and surgical dentistry. For further information, please refer to the coDiagnostiX® Manual.

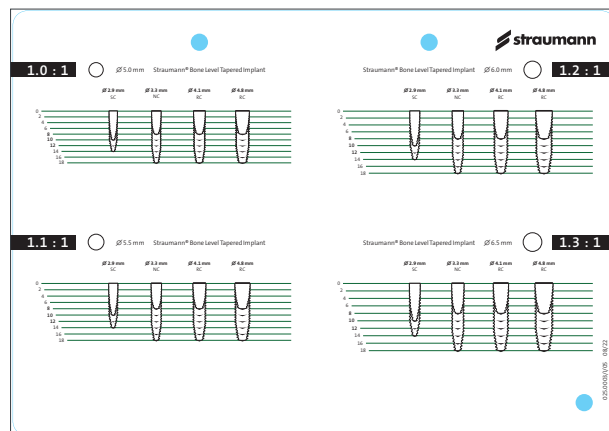

For more information regarding the preparation of the X-ray Template with the Reference Spheres see the *Straumann® Dental Implant System, Basic Information (702084/en)*.

Warning: For Bone Level Tapered Implants use only the X-ray Template specific to the Bone Level Tapered Implant.

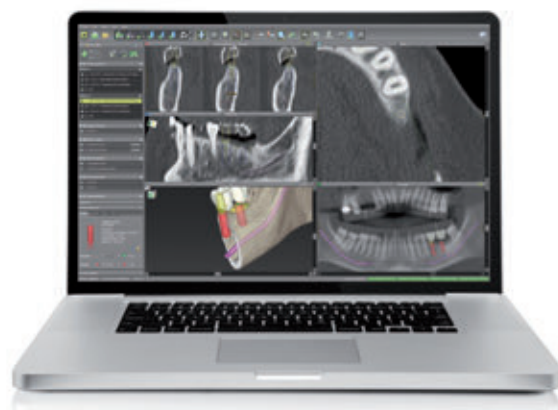

4.2.3 Straumann® Implant Distance Indicator

The Implant Distance Indicator is available for Bone Level Implants (art. no. 026.0901) and can be used for the Bone Level Tapered Implants as well.

The different disks of the Implant Distance Indicator represent the shoulder diameters of the Bone Level Implants. The Implant Distance Indicator can be used to check the available space before the start of treatment or intraoperatively to mark the desired implant site.

Implant Distance Indicator for Straumann® Bone Level Implants and Bone Level Tapered Implants



	Leg label	Disk diameter	Corresponding implants
Leg 1	BL Ø4.1	Ø4.1 mm	Bone Level Implants, Bone Level Tapered Implants Ø4.1 mm
Leg 2	BL Ø4.1	Ø4.1 mm	Bone Level Implants, Bone Level Tapered Implants Ø4.1 mm
Leg 3	BL Ø3.3	Ø3.3 mm	Bone Level Implants, Bone Level Tapered Implants Ø3.3 mm
Leg 4	BL Ø4.8	Ø4.8 mm	Bone Level Implants, Bone Level Tapered Implants Ø4.8 mm
Alternative Leg*	BL Ø2.9	Ø2.9 mm	Bone Level Tapered Implants Ø2.9 mm

*One of the disks delivered with art. no. 026.0901 can be replaced by the BL Ø2.9 disk, art. no. 025.0044.

4.2.4 Straumann® Pro Arch Guide

For intraoperative visual and three-dimensional orientation of the implant angulation (mesial/distal) and oral parallelization, use the Straumann® Pro Arch Guide.

The Pro Arch Guide is used in edentulous jaws for surgical implant placement. The Pro Arch Guide can be easily bent to adapt to the dental arch. It is secured by drilling into the symphysis with a Ø2.2 mm Pilot Drill and a pin in the jaw. The drilling depth for the bone cavity of the pin is 10 mm. The drilling depth can be checked visually using the depth markings on the drills.

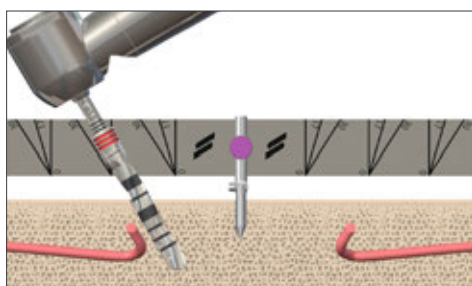

For further information about treatment of edentulous patients and angulated placement of Bone Level Tapered Implants, please refer to the *Straumann® Pro Arch, Basic Information* (490.015/en).

5 SURGICAL PROCEDURE

Depending on the bone density¹⁵ (soft/medium/hard) different drill protocols should be applied for the Bone Level Tapered Implant. This provides the flexibility to adjust the implant bed preparation to the individual bone quality and anatomical situation.

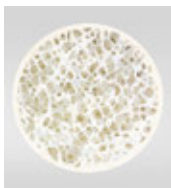
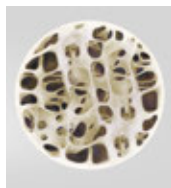
Cross sectional view of different types of bone quality*		
Type I	Type II/III	Type IV
Hard	Medium	Soft
Thick cortical bone with marrow cavity	Thin cortical bone with dense trabecular bone of good strength	Very thin cortical bone with low density trabecular bone of poor strength
		

5.1 STRAUMANN® BONE LEVEL TAPERED Ø 2.9 mm SC

5.1.1 Special indications

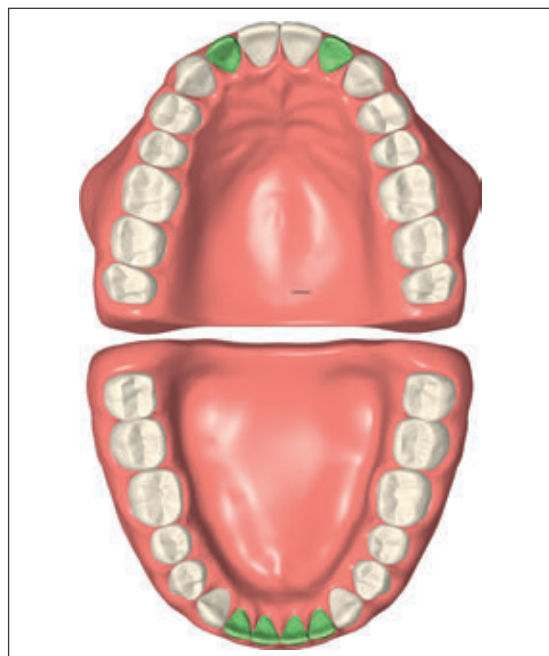

The Straumann® Bone Level Tapered Implants Ø2.9 mm are indicated for reconstruction of single defects of:

- central and lateral incisors in the lower jaw
- lateral incisors in the upper jaw.

Further information on the indications can be found on www.ifu.straumann.com.

* Lekholm U, Zarb G. Patient selection and preparation in Tissue Integrated Prostheses. Branemark P I, Zarb G A, Albrektsson T (eds). pp199–210. Quintessence, 1985.

5.1.2 Workflow

Note: For all BLT implants, either the VeloDrills™ or the BLT drills can be used for the implant osteotomy. See reference article numbers in chapter 6.7 *Article List of Instruments*.

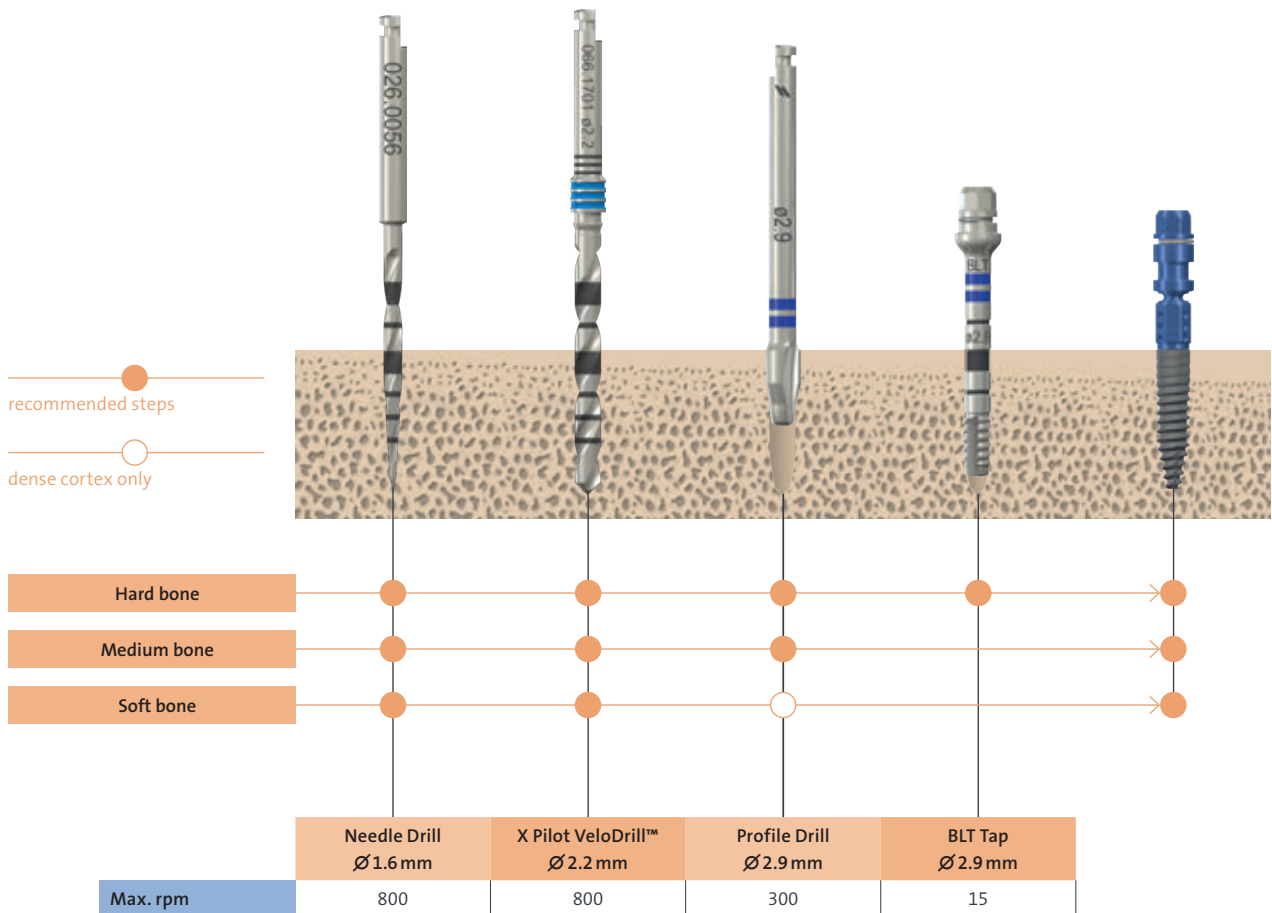

Note: In soft bone situations with a dense cortex, it is recommended to use the Profile Drill to prepare the cortical aspect of the osteotomy.

For the tap drilling, it is recommended to use the Ratchet in order not to overtap the osteotomy.

5.1.3 Position indicator

Intended use

If a restoration with a Variobase® Abutment is planned, the Position Indicator is an instrument used to ensure the correct positioning of the implant during implant bed preparation and to indicate the space taken by the abutment platform. It is made of titanium and delivered non-sterile and must be sterilized prior to use.

Characteristics



After opening the gingiva, the implant bed preparation begins with the preparation of the alveolar ridge (Step 1) and the marking of the implantation site with a Round Bur and/or with a Needle Drill (Step 1), followed by the implant bed preparation with the Needle Drill and X Pilot Drill (Steps 2 and 3). The implant bed is widened in the cortical layer with the SC BLT Profile Drill (Step 4) and the threads are pre-cut with the SC BLT Tap (Step 5).

5.1.4 Implant bed preparation

Implant bed preparation on the example of a Bone Level Tapered Implant $\varnothing 2.9$ mm/10 mm SC in hard bone.



Step 1 – Prepare alveolar ridge and mark implant position

Carefully reduce and smooth a narrow tapering ridge with a large Round Bur. This will provide a flat bone surface and a sufficiently wide area of bone. Mark the implantation site determined during the implant position planning with the $\varnothing 1.4$ mm Round Bur and/or the $\varnothing 1.6$ mm Needle Drill

Note: This step may not be applicable or may differ depending on the clinical situation (e.g. fresh extraction socket).

Note: If the Distance Indicator is used together with the Needle Drill to mark the implant position, make sure not to drill more than 3 mm in order to avoid any collision between the Needle Drill and the Distance Indicator.

Caution: Handling with care at all times is recommended to avoid needlesticks.

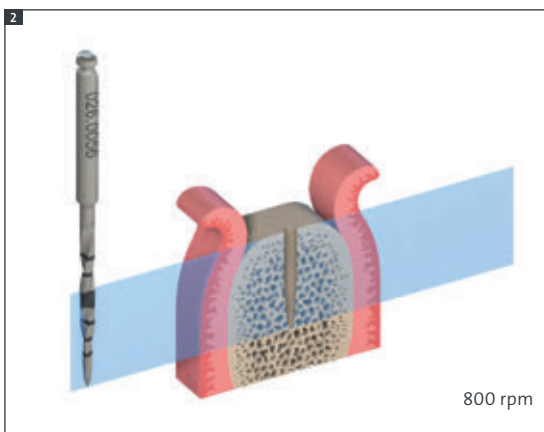

Step 2 – Implant axis and depth

For $\varnothing 2.9$ mm implants, mark the implant axis with the Needle Drill to a maximum depth of 6 mm. Use the needle drill to check the axis orientation.

Drill the implant bed to the final depth with the Needle Drill, while correcting any unsatisfactory implant axis orientation. Use the Needle Drill to check the implant axis and preparation depth.

For $\varnothing 2.9$ mm implants in soft bone, the implant bed preparation ends here.

Note: With a dense cortex, it is recommended to use the Profile Drill to prepare the cortical aspect of the osteotomy.

Caution: At this point take an X-ray, particularly with vertically reduced bone availability.

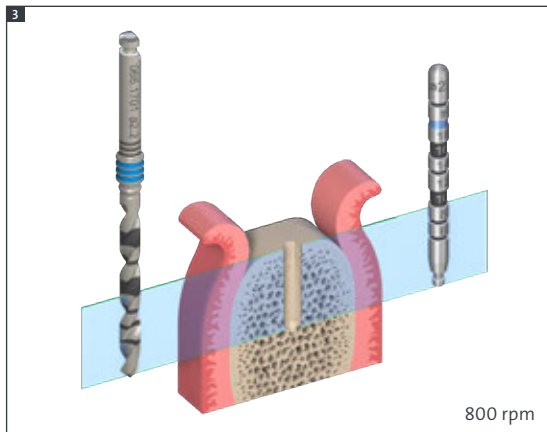

Step 3 – Widen implant bed to \varnothing 2.2 mm

With the \varnothing 2.2 mm X Pilot VeloDrill™, drill to a depth of about 6 mm. Insert the \varnothing 2.2 mm Alignment Pin to check for correct implant axis orientation. Use the \varnothing 2.2 mm X Pilot VeloDrill™ to prepare the implant bed to final preparation depth.

If necessary, correct any unsatisfactory implant axis orientation. Use the \varnothing 2.2 mm Alignment Pin again to check the implant axis and preparation depth.

For \varnothing 2.9 mm implants, also use the Position Indicator to check the available space for the future prosthetic solution if a restoration with a Variobase® Abutment is planned.

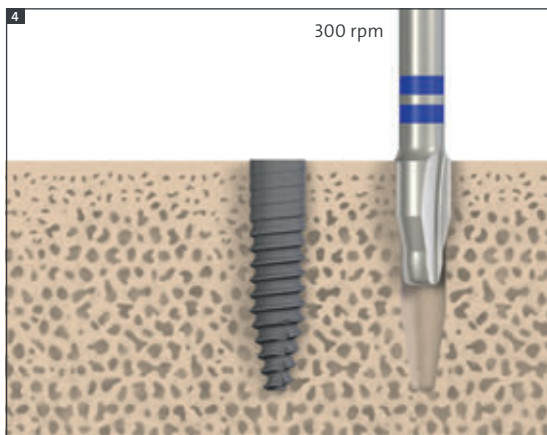

Step 4 – Profile drilling

Shape the coronal part of the implant bed with the Profile Drill according to the diameter by using the orientation features as guidelines for vertical position.

The implant bed preparation in medium bone ends here.

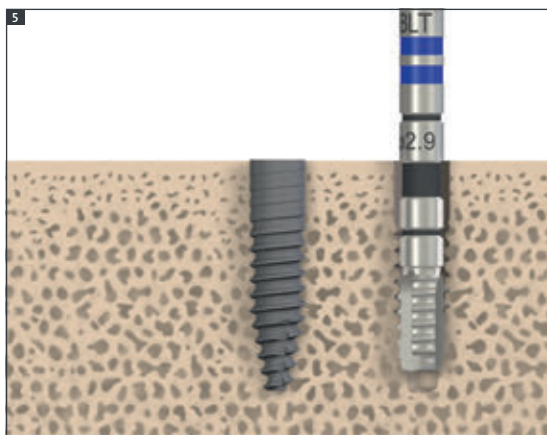

Step 5 – Tap drilling

Precut the threads with the Tap Drill over the depth of max 12 mm in hard bone. For this step, it is recommended to use the Ratchet in order not to overtap the osteotomy.

5.1.5 Implant placement

A Straumann® implant can be placed with the Handpiece or manually with the Ratchet. A maximum speed of 15rpm is recommended.

Note: Straumann® Bone Level Tapered Implants must be rotationally oriented for both Handpiece and Ratchet insertion (see Step 4).

The following instructions show how a Straumann® Bone Level Tapered Implant Ø2.9 mm SC is placed with the Ratchet and/or Handpiece.

For narrow interdental spaces, new adapters with an outer diameter of 4.0 mm will be available for both Ratchet and Handpiece that will fit the new Loxim® for the Straumann® Bone Level Tapered Ø2.9 mm SC.

Features	Benefits
Snap-in mounting for easy handling without counter-maneuvering
Blue color for high visibility
Compact dimensions for easy access
Height markings for correct implant placement
Pre-determined breaking point avoids bone overcompression



5.1.6 Soft tissue management

The Straumann® Bone Level Tapered Implant Ø2.9 mm SC puts a strong emphasis on esthetic considerations.

It offers tailor-made solutions that allow for natural soft tissue shaping and maintenance for its indications. A versatile portfolio of healing and temporary abutments is available.

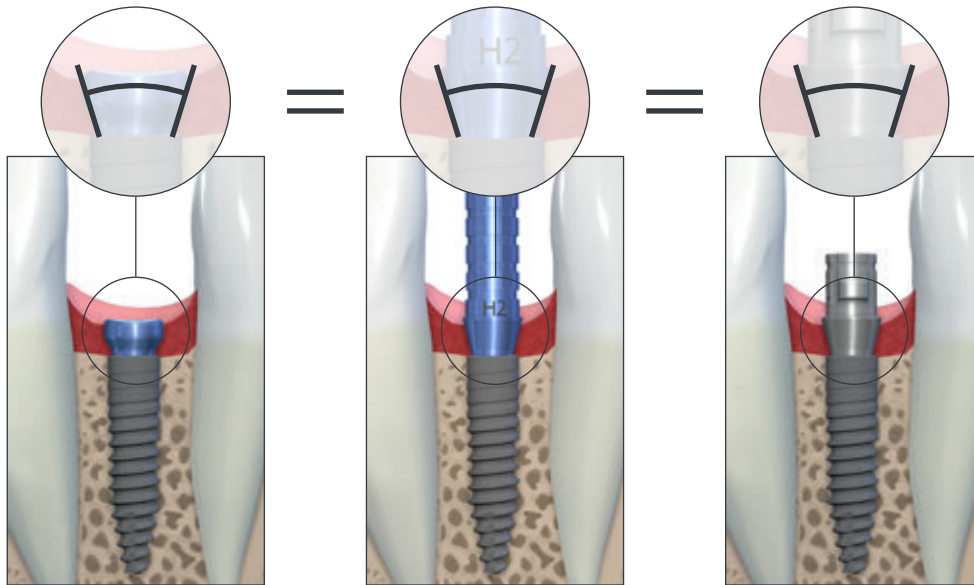

Esthetic results are crucially determined by successful soft tissue management. To optimize the soft tissue management process, various components with Consistent Emergence Profiles™ are available in the prosthetic portfolio of the Straumann® BLT Implant Ø2.9 mm SC. This applies for all healing abutments, the temporary abutments and the abutments for the final restoration. Thus, the emergence profiles are uniform throughout the treatment process.

5.2 STRAUMANN® BONE LEVEL TAPERED Ø 3.3 mm, Ø 4.1 mm AND Ø 4.8 mm

5.2.1 Workflow

5.2.1.1 Straumann® Bone Level Tapered Ø3.3 mm NC

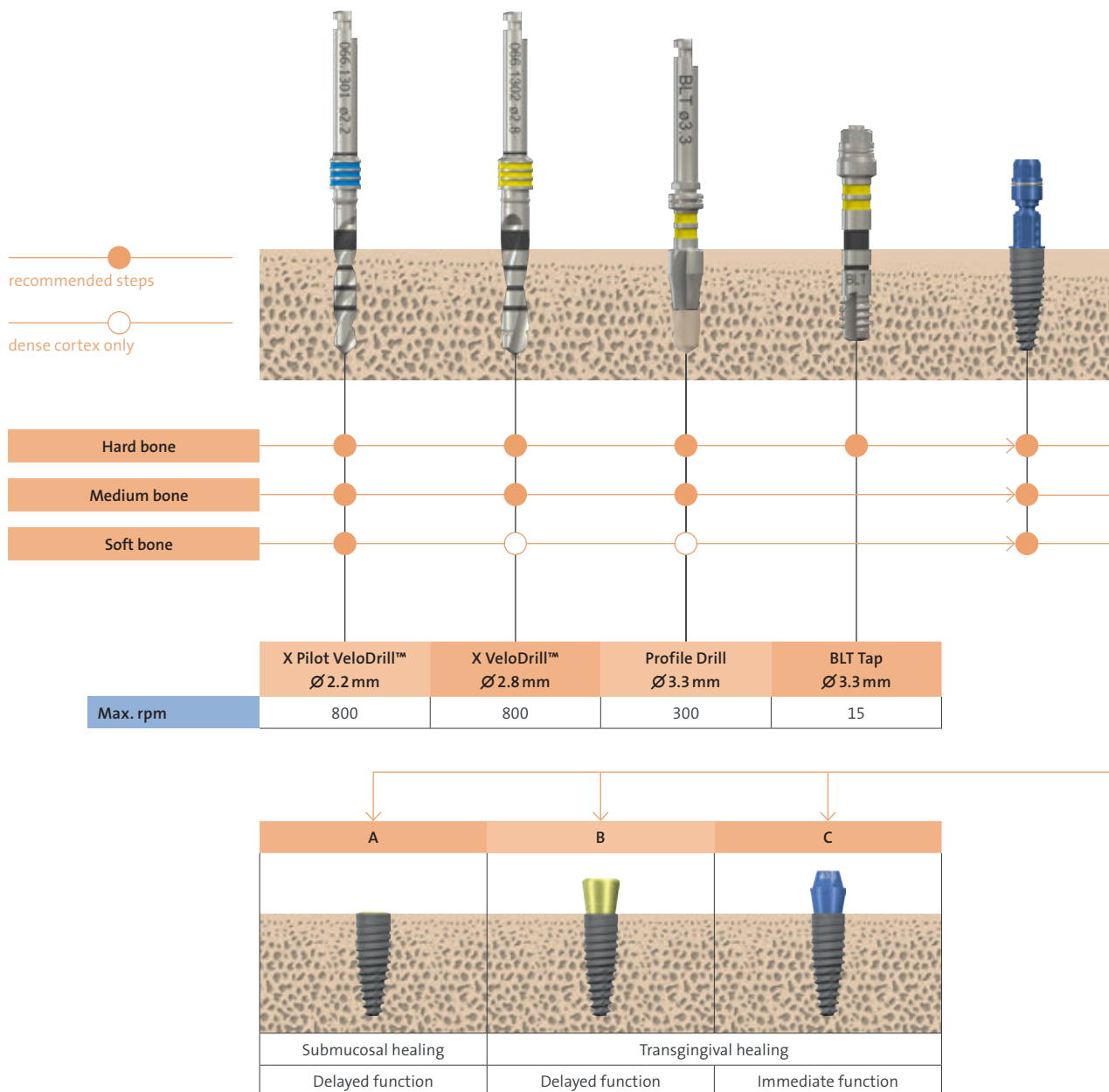

Note: In soft bone situations with a dense cortex, it is recommended to use the Profile Drill to prepare the cortical aspect of the osteotomy.

5.2.1.2 Straumann® Bone Level Tapered Ø4.1 mm RC

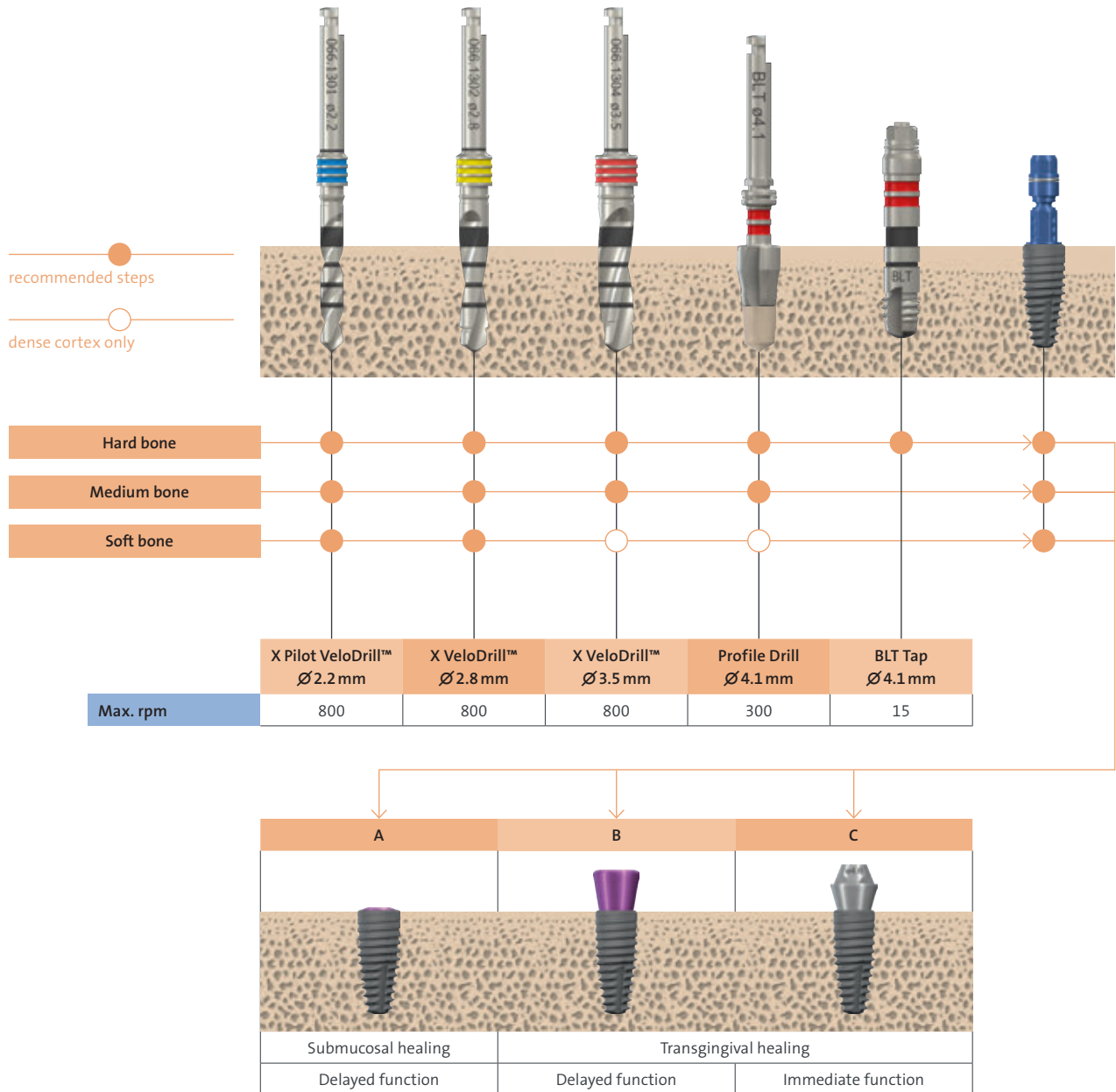

Note: In soft bone situations with a dense cortex, it is recommended to use the Profile Drill to prepare the cortical aspect of the osteotomy.

5.2.1.3 Straumann® Bone Level Tapered Ø4.8 mm RC

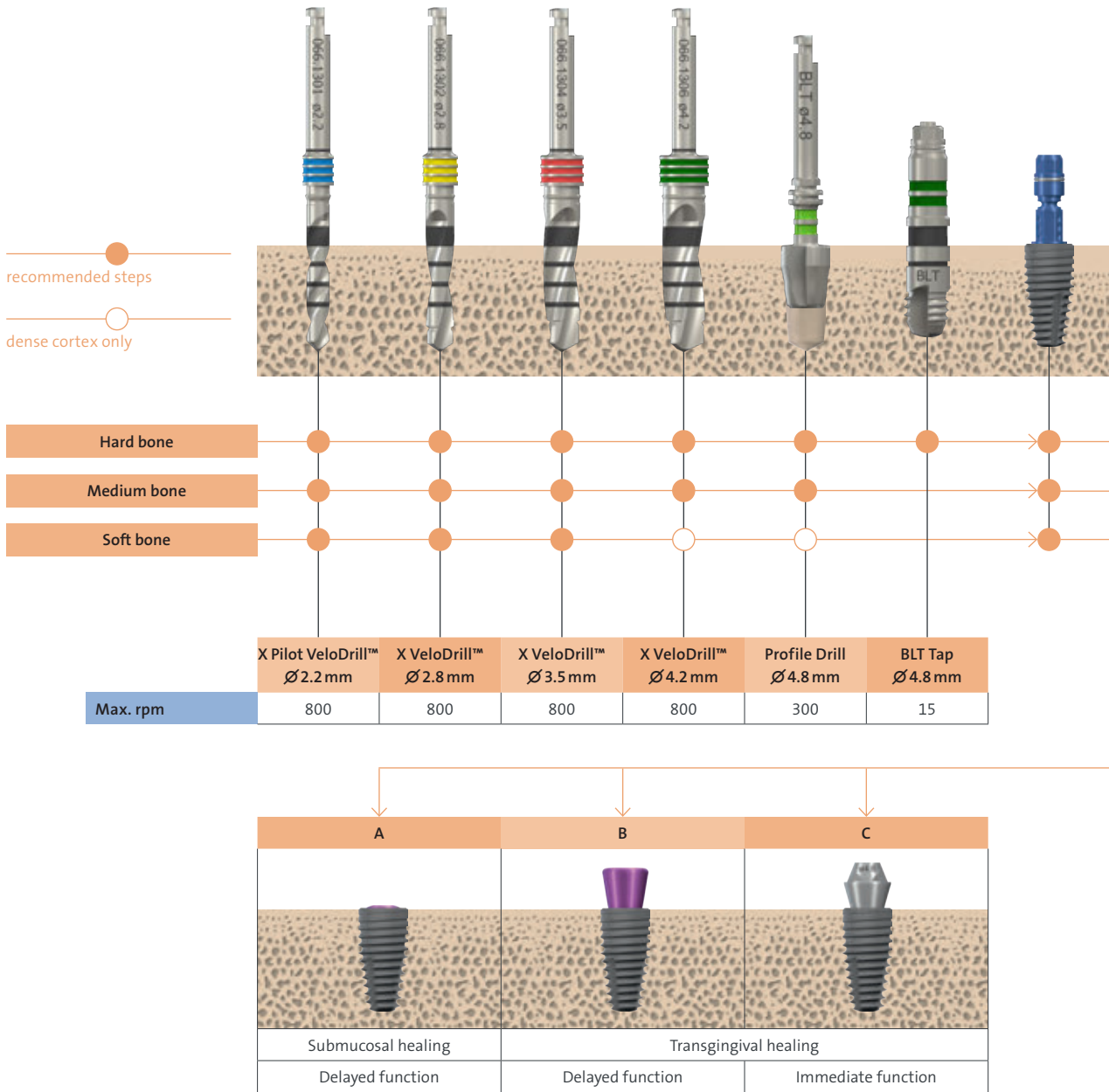

Note: In soft bone situations with a dense cortex, it is recommended to use the Profile Drill to prepare the cortical aspect of the osteotomy.

5.2.2 Implant bed preparation

Implant bed preparation on the example of a Bone Level Tapered Implant $\varnothing 4.1$ mm/10 mm RC in hard bone. For specific information about the BLT $\varnothing 2.9$ mm, please refer to section 5.1.4.

After opening the gingiva, the implant bed preparation begins with the preparation of the alveolar ridge (Step 1) and the marking of the implantation site with a Round Bur (Step 1), followed by the implant bed preparation with the X Pilot VeloDrill™ and the X VeloDrill™ (Step 2 and 3), according to the endosteal implant diameter. Alternatively, BLT drills can be used instead of VeloDrills™. Please see article list for BLT drills in chapter 6.7. The implant bed is widened in the cortical layer with the BLT Profile Drill (Step 5) and the threads are precut with the BLT Tap (Step 6).



Step 1 – Prepare alveolar ridge and mark implant position

Carefully reduce and smooth a narrow tapering ridge with a large Round Bur. This will provide a flat bone surface and a sufficiently wide area of bone. Mark the implantation site determined during the implant position planning with the $\varnothing 1.4$ mm Round Bur or $\varnothing 1.6$ mm Needle Drill.

Note: This step may not be applicable or may differ depending on the clinical situation (e.g. fresh extraction socket).

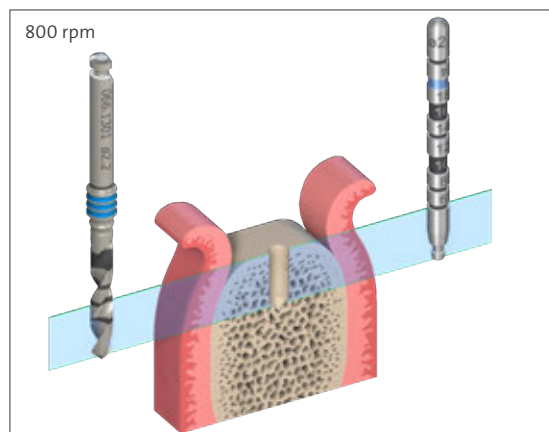

Step 2 – Implant axis and depth

With the $\varnothing 2.2$ mm X Pilot VeloDrill™, mark the implant axis by drilling to a depth of about 6 mm. Insert the $\varnothing 2.2$ mm Alignment Pin to check for correct implant axis orientation.

Use the $\varnothing 2.2$ mm X Pilot VeloDrill™ to prepare the implant bed to the final preparation depth. If necessary, correct any unsatisfactory implant axis orientation.

Use the $\varnothing 2.2$ mm Alignment Pin again to check the implant axis and preparation depth.

Caution: At this point take an X-ray, particularly with vertically reduced bone availability. The Alignment Pin is inserted into the drilled area, which allows a comparative visualization of the drill hole in relation to the anatomical structures.

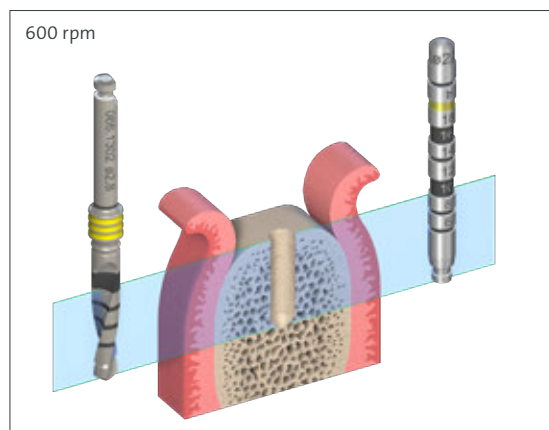

Step 3 – Widen implant bed to $\varnothing 2.8$ mm

Widen the implant bed with the $\varnothing 2.8$ mm X VeloDrill™. If necessary, correct the implant bed position. Use the $\varnothing 2.8$ mm Depth Gauge to check the preparation depth.

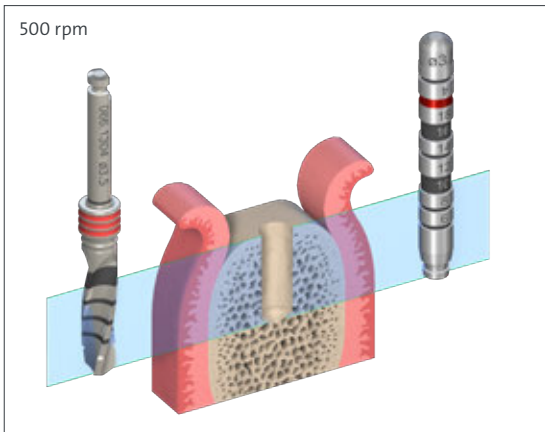

Step 4 – Widen implant bed to Ø3.5 mm

Widen the implant bed with the Ø3.5 mm X VeloDrill™. If necessary, correct the implant bed position.

Use the Ø3.5 mm Depth Gauge to check the preparation depth.

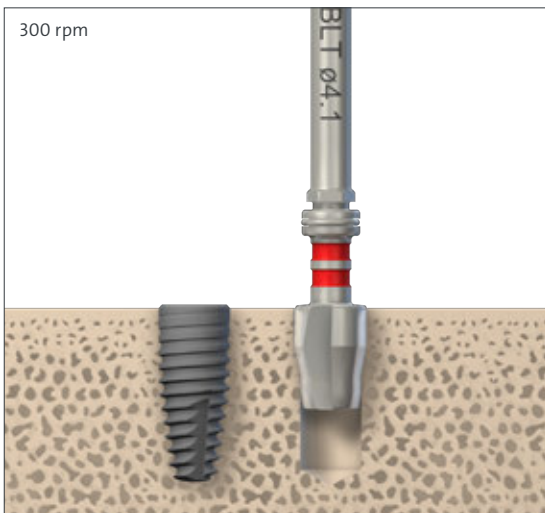

Step 5 – Profile drilling

Shape the coronal part of the implant bed with the Ø4.1mm Profile Drill with the edge of the outer rim at bone level.

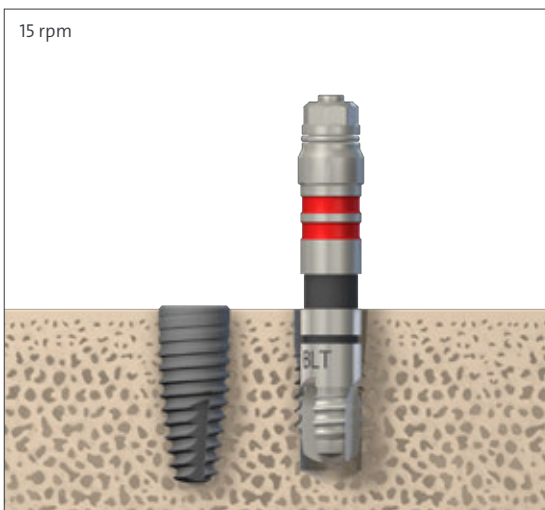

Step 6 – Tap drilling

Precut the threads with the Ø4.1mm Tap Drill over the depth of 10 mm.

Caution: Profile Drills and Taps marked with two color rings must only be used for the Bone Level Tapered Implant system.

5.2.3 Implant placement

A Straumann® implant can be placed with the Handpiece or manually with the Ratchet.

Do not exceed the recommended maximum speed of 15 rpm when you use the Handpiece.

Note: Straumann® Bone Level Tapered Implants must be rotationally oriented for both Handpiece and Ratchet insertion (see Step 4).

The following step-by-step instructions show how a Bone Level Tapered Implant is placed with the Ratchet.



Step 1 – Attach Ratchet Adapter

Hold the enclosed part of the implant carrier. Attach the Ratchet Adapter to the Loxim®. You hear a click when the Adapter is attached correctly.



Step 2 – Remove implant from the carrier

Pull down the implant carrier and, simultaneously, lift the implant out of the implant carrier (keep your arms steady).

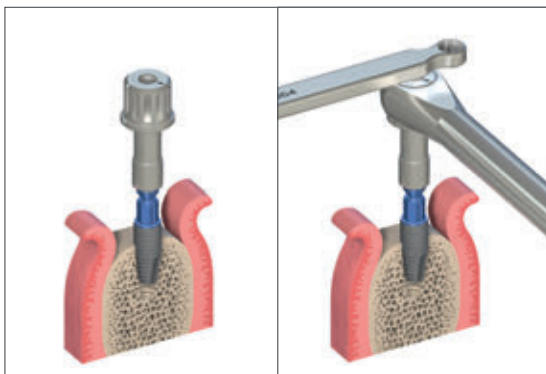

Step 3 – Place implant

Place the implant with the Ratchet Adapter into the implant bed. Use the Ratchet to move the implant into its final position turning it clockwise.

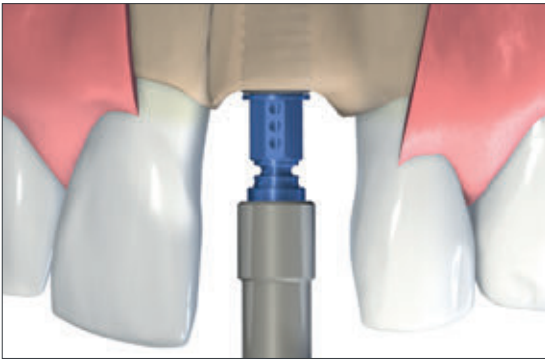

Step 4 – Correct implant orientation

While approaching the final implant position, make sure that the height markings on the blue transfer part are oriented exactly orofacially. This positions the four protrusions of the internal connection for ideal prosthetic abutment orientation. A turn to the next marking corresponds to a vertical displacement of 0.2 mm.

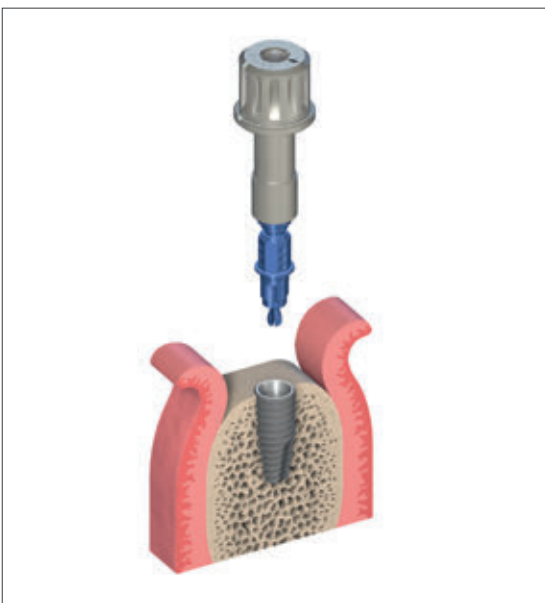

Step 5 – Remove Loxim®

The Loxim® can easily be re-inserted to finish an uncompleted implant placement until the implant is fully inserted. If the implant needs to be removed during implantation surgery, the Loxim® allows for counter-clockwise turns. After insertion, detach the Loxim® with the Adapter.

If an insertion torque of over 35 Ncm is achieved before the implant has assumed its final position, check that the implant bed preparation is correct to avoid bone overcompression. The Loxim® is provided with a pre-determined breaking point at 80 Ncm to prevent damage to the inner configuration of the implant, thus ensuring the integrity of the interface for mounting the prosthesis.

After breakage of the Loxim®, the remaining part of the Loxim® in the implant must be removed and the implant, if not fitted correctly, has to be unscrewed with a 48h Explantation Device. The implant bed then has to be re-prepared and a new implant inserted. For further details, please consult the brochure *Guidance for Implant Removal, Basic Information (702085/en)*.

5.2.3.1 Immediate placement in extraction sites

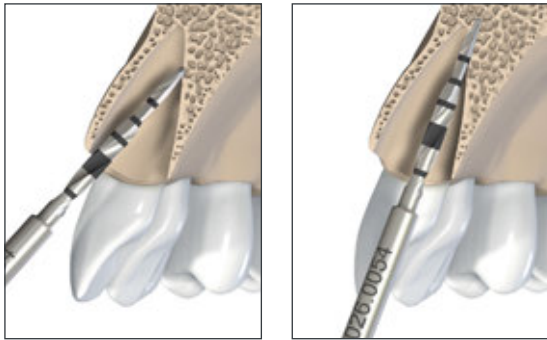

Step 1 – Implant bed preparation

Start with the Round Bur to create a purchase point at the apical part of the extraction socket. Optionally, start with the needle drill in the palatal direction, then straighten the drill direction to the intended implant bed axis. Drill 2 to 3 mm only, maximum to implant length.

Note: Prep the palatal wall with the Round Bur or side cutter bur to straighten the implant bed on the palatal side.

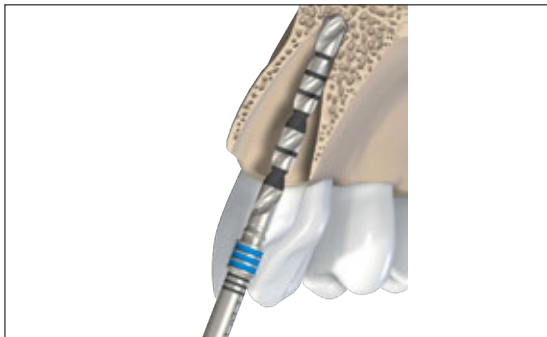

Step 2 – Implant axis and depth

Pre-drill the implant bed with the $\varnothing 2.2$ mm X Pilot VeloDrill™ to mark the implant axis on the palatal side of the extraction socket. Potentially direct palatally and re-direct after 1-2 mm to the implant direction. Always apply lateral bur pressure towards the palate with the burs while drilling. Insert the Alignment Pin $\varnothing 2.2$ mm to check for correct implant axis orientation and preparation depth. Widen the implant bed and correct the implant bed position if necessary. Use the drill protocol for soft bone.

Note: First drill at a steep angle to straighten out the palatal wall.

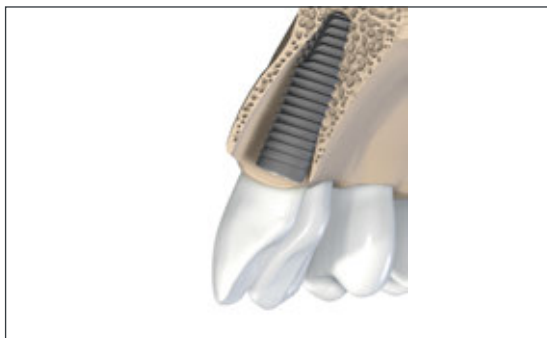

Step 3 – Implant placement

Angle the implant at insertion palatally until engaged in the bone, then redirect to the final implant bed position.

Note: If placed sub-osseous, consider scalloping the palatal bone to create space for the healing abutment or provisional.



Step 4 – Consider bone augmentation

Consider filling the gap between implant and buccal bone with bone chips. Complete with any required bone augmentation procedure on the buccal wall.

5.2.4 Soft tissue management

After implantation, close the implant – hand-tightened – with a Closure Screw or a Healing Abutment to protect the implant. The surgeon can choose between submucosal and transgingival healing and has many options available for soft tissue management through a set of secondary healing components.

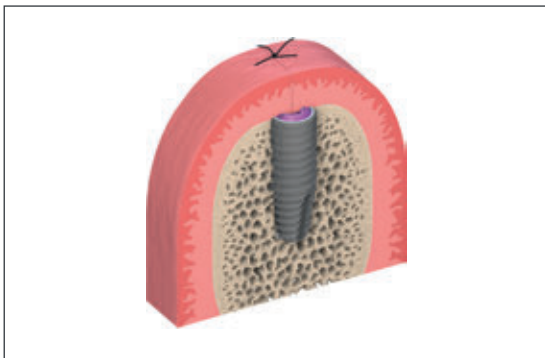

Submucosal healing

For submucosal healing (healing under closed mucoperiosteal flap) the use of a Closure Screw is recommended. Submucosal healing is suggested in esthetic indications and for implantations with simultaneous guided bone restoration (GBR) or membrane technique. A second surgical procedure is required for uncovering the implant and inserting the desired secondary component.

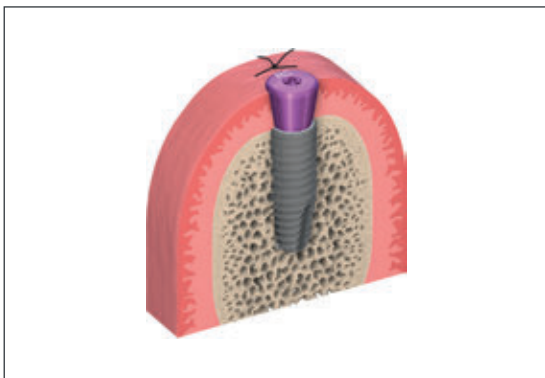

Transgingival healing – Delayed function

Straumann® implants come with a versatile portfolio of Healing Abutments enabling soft-tissue sculpting during transgingival healing. They are recommended for intermediate use. After the soft-tissue healing phase they are replaced with the appropriate temporary or final restoration.

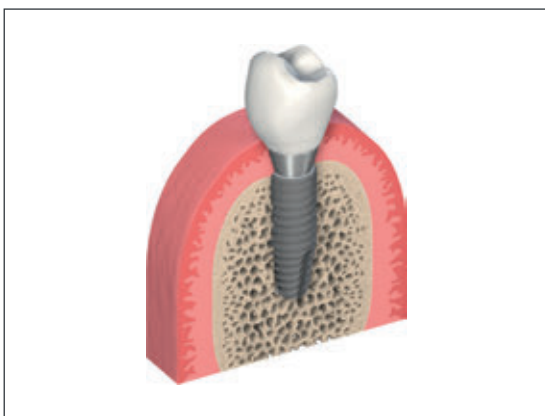

Transgingival healing – Immediate function

Straumann® implants are suitable, within the scope of indications, for immediate and early restoration in single-tooth gaps and edentulous or partially edentulous jaws. Good primary stability and an appropriate occlusal load are essential. For immediate provisional restoration, the Bone Level prosthetic portfolio offers a wide range of temporary and final abutments.

For further information please see the *Straumann® Bone Level Prosthetic Procedures, Basic Information (702061/en)*.

6 INSTRUMENTS

6.1 DEPTH MARKS ON STRAUMANN® INSTRUMENTS

Straumann® instruments have depth marks in 2 mm intervals that correspond to the available implant lengths. The first bold mark on the drills represents 10 mm and 12 mm, where the lower edge of the mark corresponds to 10 mm and the upper edge to 12 mm. The second bold mark on the long drills represents 16 mm and 18 mm, where the lower edge of the mark corresponds to 16 mm and the upper edge to 18 mm.

Warning: Due to the function and design of the drills, the drill tip is 0.5 mm longer than the insertion depth of the implant.

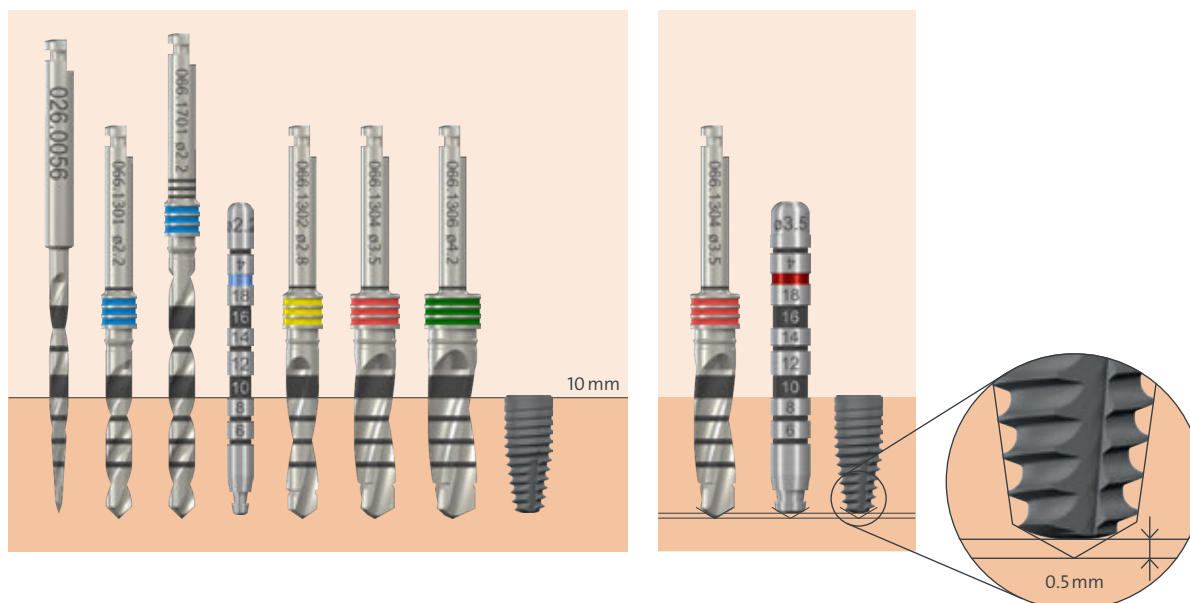

Caution: Do not use the former Alignment Pins and Depth Gauges with the Bone Level Tapered Implant since they will indicate a wrong depth.

6.2 DRILL EXTENDER

The Drill Extender (art. no. 040.563) can be used with Profile Drills to increase the overall instrument length by 15 mm. This helps to gain access between long crowns of adjacent teeth.

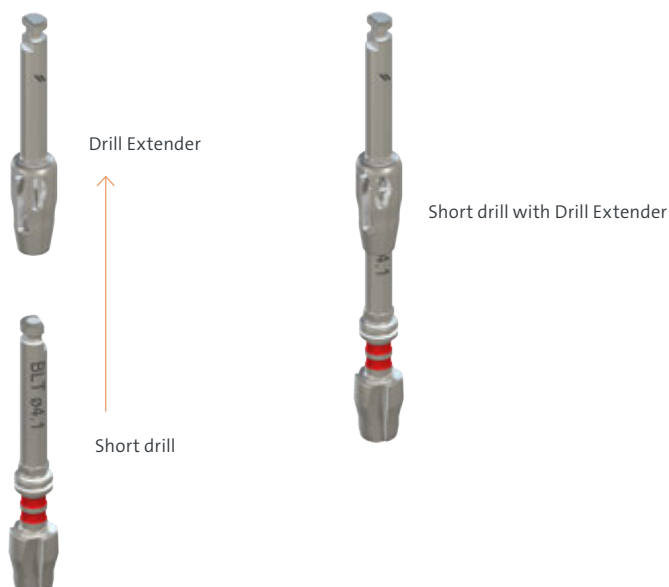

6.3 RATCHET

Ratchet

The Ratchet (art. no. 046.119) of the Straumann® Dental Implant System is a two-part lever arm instrument with a rotary knob for changing the direction of force.

The Ratchet is required for the following operations:

- Manual thread tapping.
- Manual placement of implants into their final position in the implant bed.
- Manual screwing of healing caps and closure screws*.
- Screwing of abutments and occlusal screws*.

*Combined with the torque control device for defined torque



Service Instrument

The Ratchet is supplied with a Service Instrument, which is used to loosen or tighten the retaining screw.



Ratchet disassembled

After loosening, the Ratchet bolt can be removed from the body of the Ratchet. It must be disassembled for cleaning and sterilization.

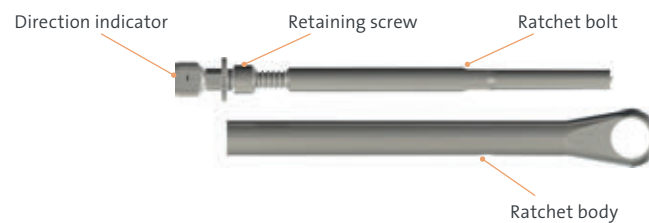

6.4 TORQUE CONTROL DEVICE

The Torque Control Device (art. no. 046.049) is an instrument for determining the torque applied to various screw connections. A specific force/torque (Ncm) is transferred to the screw connection by means of a torque bar mounted on the ratchet. A calibration mark shows the measured tightening torque.

If the torque bar is aligned with the zero mark at rest, the precision of the displayed tightening torque is within ± 2 Ncm. The torque bar must not be bent beyond the calibration mark on the scale, otherwise the precision can no longer be guaranteed or the bar may break.

Recommended torque values are defined by optimal conditions for the specific screw connections of the Straumann® System. The individual clinical situation (bone quality, implant length, implant type, implant surface, time of application of force, etc.) also has to be considered apart from the recommended torque values.

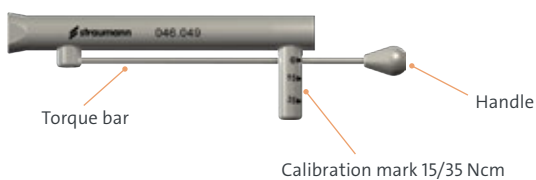

Assembled Torque Control Device and Ratchet



Maximum torque - reference mark on the scale

Recommendations for correct torque with the Straumann® Dental Implant System

Connection	Recommended torque
Abutment incl. angled abutments)	35 Ncm
Closure screws	15 Ncm
Healing caps	15 Ncm
Occlusal screws	15 Ncm

Bone graft System

Connection	Recommended torque
Basal screw	35 Ncm
Mucosa cylinder	35 Ncm
Bone graft abutment	15 Ncm

6.5 CLEANING AND CARE OF INSTRUMENTS

Careful treatment of all instruments is of the utmost importance. Even slight damage, for instance to the drill tips (e.g., when the drills are “thrown” into a bowl of water), impairs cutting performance and thus the clinical result. With correct and careful care, the high quality of the material and excellent workmanship ensure that the rotating instruments can be used repeatedly (up to a maximum of ten times is recommended). The *Surgery Tracking Sheet for Straumann® Cutting Instruments* (152.755/en) helps to give an overview of how often the individual instruments have already been used.

Straumann instruments with high cutting performance are a basic requirement for successful implantation. The following should therefore be remembered:

- Never allow instruments to land on their tips.
- Use each instrument only for its intended purpose.
- Never let surgical residues (blood, secretion, tissue residues) dry on an instrument; clean immediately after surgery.
- Thoroughly clean off incrustations with soft brushes only. Disassemble instruments, clean cavities especially well.
- Never disinfect, clean (also ultrasound) or sterilize instruments made of different materials together.
- Use only cleaning agents and disinfectants intended for the material and follow the instructions for use of the manufacturer.
- Rinse disinfectants and cleaning agents very thoroughly with water.
- Never leave or store instruments moist or wet.



For more detailed information please see the brochure *Straumann® Surgical and Prosthetic Instruments, Care and Maintenance* (702000/en).

6.6 STRAUMANN® MODULAR CASSETTE





































The Straumann® Modular Cassette is used for the secure storage and reprocessing of surgical and auxiliary instruments of the Straumann® Dental Implant System. The Straumann® Modular Cassette works with any Straumann® implant line, including with the Straumann® guided surgery workflow.



For information on how to equip the Cassette, please see the brochure *Straumann® Modular Cassette Selection Guide* (702824/en).

For more technical information, please see the brochure *Straumann® Modular Cassette - Basic Information* (702527/en).

6.7 ARTICLE LIST OF INSTRUMENTS

Art. No.	Picture	Article	Material
B Module			
026.0004		BLT Profile Drill, long, length 33 mm, Ø 3.3 mm	Stainless steel
026.0006		BLT Profile Drill, long, length 33 mm, Ø 4.1 mm	Stainless steel
026.0008		BLT Profile Drill, long, length 33 mm, Ø 4.8 mm	Stainless steel
026.0061		BLT Profile Drill, short, length 25 mm, Ø 2.9 mm	Stainless steel
026.0062		BLT Profile Drill, long, length 33 mm, Ø 2.9 mm	Stainless steel
026.0063		BLT Tap, length 25 mm, Ø 2.9 mm	Stainless steel/TAN
034.257		BLT Pilot Drill, short, guided, length 33.4 mm, Ø 2.2 mm	Stainless steel
034.258		BLT Pilot Drill, medium, guided, length 37.4 mm, Ø 2.2 mm	Stainless steel
034.259		BLT Pilot Drill, long, guided, length 41.4 mm, Ø 2.2 mm	Stainless steel
034.260		BLT Drill, short, guided, length 33.4 mm, Ø 2.8 mm	Stainless steel
034.261		BLT Drill, medium, guided, length 37.4 mm, Ø 2.8 mm	Stainless steel
034.262		BLT Drill, long, guided, length 41.4 mm, Ø 2.8 mm	Stainless steel
034.263		BLT Drill, short, guided, length 33.4 mm, Ø 3.5 mm	Stainless steel
034.264		BLT Drill, medium, guided, length 37.4 mm, Ø 3.5 mm	Stainless steel
034.265		BLT Drill, long, guided, length 41.4 mm, Ø 3.5 mm	Stainless steel
034.266		BLT Drill, short, guided, length 33.4 mm, Ø 4.2 mm	Stainless steel
034.267		BLT Drill, medium, guided, length 37.4 mm, Ø 4.2 mm	Stainless steel
034.268		BLT Drill, long, guided, length 41.4 mm, Ø 4.2 mm	Stainless steel
034.324		BLT Profile Drill, short, FIBA compatible, length 27 mm, Ø 3.3 mm	Stainless steel
034.325		BLT Profile Drill, short, FIBA compatible, length 27 mm, Ø 4.1 mm	Stainless steel
034.326		BLT Profile Drill, short, FIBA compatible, length 27 mm, stainless steel, Ø 4.8 mm	Stainless steel
034.345		BLT Tap, short, FIBA compatible, length 21 mm, Ø 3.3 mm	Stainless steel
034.346		BLT Tap, short, FIBA compatible, length 21 mm, Ø 4.1 mm	Stainless steel
034.347		BLT Tap, short, FIBA compatible, length 21 mm, Ø 4.8 mm	Stainless steel
066.1301		X Pilot VeloDrill™, guided, short, Ø 2.2 mm	Stainless steel
066.1302		X VeloDrill™, guided, short, Ø 2.8 mm	Stainless steel
066.1304		X VeloDrill™, guided, short, Ø 3.5 mm	Stainless steel
066.1306		X VeloDrill™, guided, short, Ø 4.2 mm	Stainless steel
066.1501		X Pilot VeloDrill™, guided, medium, Ø 2.2 mm	Stainless steel
066.1502		X VeloDrill™, guided, medium, Ø 2.8 mm	Stainless steel
066.1504		X VeloDrill™, guided, medium, Ø 3.5 mm	Stainless steel
066.1506		X VeloDrill™, guided, medium, Ø 4.2 mm	Stainless steel
066.1701		X Pilot VeloDrill™, guided, long, Ø 2.2 mm	Stainless steel
066.1702		X VeloDrill™, guided, long, Ø 2.8 mm	Stainless steel
066.1704		X VeloDrill™, guided, long, Ø 3.5 mm	Stainless steel
066.1706		X VeloDrill™, guided, long, Ø 4.2 mm	Stainless steel

7 IMPORTANT GUIDELINES

Please note

Practitioners must have appropriate knowledge and instruction in the handling of the Straumann CAD/CAM products or other Straumann products ("Straumann Products") for using the Straumann Products safely and properly in accordance with the instructions for use.

The Straumann Product must be used in accordance with the instructions for use provided by the manufacturer. It is the practitioner's responsibility to use the device in accordance with these instructions for use and to determine whether the device fits the patient's individual situation.

The Straumann Products are part of an overall concept and must be used only in conjunction with the corresponding original components and instruments distributed by Institut Straumann AG, its ultimate parent company and all affiliates or subsidiaries of such parent company ("Straumann"), except if stated otherwise in this document or in the instructions for use for the respective Straumann Product. If use of products made by third parties is not recommended by Straumann in this document or in the respective instructions for use, any such use will void any warranty or other obligation, express or implied, of Straumann.

Availability

Some of the Straumann Products listed in this document may not be available in all countries.

Caution

In addition to the caution notes in this document, our products must be secured against aspiration when used intraorally.

Validity

Upon publication of this document, all previous versions are superseded.

Documentation

For detailed instructions on the Straumann Products contact your Straumann representative.

Copyright and trademarks

Straumann® documents may not be reprinted or published, in whole or in part, without the written authorization of Straumann.

Straumann® and/or other trademarks and logos from Straumann® mentioned herein are the trademarks or registered trademarks of Straumann Holding AG and/or its affiliates.

1 Norm ASTM F67 (states min. tensile strength of annealed titanium). 2 Data on file for Straumann cold-worked titanium and Roxolid® Implants, MAT 13336, 20131009. 3 Gottlow J et al. : Evaluation of a new titanium-zirconium dental implant: a biomechanical and histological comparative study in the mini pig. *Journal of Clinical Implant Dentistry and Related Research* 2012; 14: 538-545 4 Wen B et al. : The osseointegration behavior of titanium-zirconium implants in ovariectomized rabbits. *Clin Oral Implants Res.* 2013 Feb 21. 5 Barter S et al. : A pilot study to evaluate the success and survival rate of titanium-zirconium implants in partially edentulous patients: results after 24 months of follow-up. *Clin Oral Implants Res.* 2012 Jul;23(7):873-81 6 Nicolau P et al. : Immediate and early loading of chronically modified implants in posterior jaws: 3-year results from a prospective randomized study. *Clin Implant Dent Relat Res.* 2013 Aug;15(4):600-612 7 Raghavendra S et al. *Int. J. Oral Maxillofac. Implants.* 2005 May-Jun;20(3):425-31. 8 Lang, NP et al. : Early osseointegration to hydrophilic and hydrophobic implant surfaces in humans. *Clin Oral Implants Res* 22.4 (2011): 349-56 9 Lekholm U et al. : Patient selection and preparation. *Tissue integration prostheses.* Chicago: Quintessence Publishing Co. Inc. 1985; 199-209 10 Rupp F et al. : Enhancing surface free energy and hydrophilicity through chemical modification of microstructured titanium implant surfaces. *Journal of Biomedical Materials Research A*, 76(2):323-334, 2006. 11 DeWild M : Superhydrophilic SLActive® implants. Straumann document 151.52, 2005 12 Maniura K : Laboratory for Materials – Biology Interactions Empa, St. Gallen, Switzerland Protein and blood adsorption on Ti and TiZr implants as a model for osseointegration. EAO 22nd Annual Scientific Meeting, October 17 – 19 2013, Dublin 13 Schwarz F et al. : Bone regeneration in dehiscence-type defects at non-submerged and submerged chemically modified (SLActive®) and conventional SLA® titanium implants: an immunohistochemical study in dogs. *J Clin.Periodontol.* 35.1 (2008): 64– 75. 14 Rausch-fan X et al. : Differentiation and cytokine synthesis of human alveolar osteoblasts compared to osteoblast-like cells (MG63) in response to titanium surfaces. *Dental Materials* 2008 Jan;24(1):102-10. Epub 2007 Apr 27. 15 Schwarz F et al. : Histological and immunohistochemical analysis of initial and early osseous integration at chemically modified and conventional SLA® titanium implants: Preliminary results of a pilot study in dogs. *Clinical Oral Implants Research*, 11(4): 481-488, 2007. 16 Lang, NP et al. : Early osseointegration to hydrophilic and hydrophobic implant surfaces in humans. *Clin Oral Implants Res* 22.4 (2011): 349-56. 17 Raghavendra S et al. : *Int. J. Oral Maxillofac. Implants.* 2005 May-Jun;20(3):425-31. 18 Oates TW et al. : Enhanced implant stability with a chemically modified SLA® surface: a randomized pilot study. *Int. J. Oral Maxillofac. Implants.* 2007;22(5):755-760. 19 Schwarz F et al. : Bone regeneration in dehiscence-type defects at chemically modified (SLActive®) and conventional SLA® titanium implants: a pilot study in dogs. *J Clin.Periodontol.* 34.1 (2007): 78-86

702.167/en/G/06 10/23
490.038/en/G/06 10/23

International Headquarters

Institut Straumann AG
Peter Merian-Weg 12
CH-4002 Basel, Switzerland
Phone +41 (0)61 965 11 11
Fax +41 (0)61 965 11 01
www.straumann.com

© Institut Straumann AG, 2023. All rights reserved.

Straumann® and/or other trademarks and logos from Straumann® mentioned herein are the trademarks or registered trademarks of Straumann Holding AG and/or its affiliates.

 **straumann**